

INT69 UY® Diagnose

INT69 UY® Diagnose



INT69 UY Diagnose

Application

The phase monitor INT69 UY Diagnose is a further development of the reliable KRIWAN phase monitors. An additional input for a PTC as well as the flexible-response protective functions help to improve the availability and extend the service life of the system.

It is used in any situation where impermissible voltages or a wrong phase sequence may cause damage or prevent proper function of the monitored system.

Functional description

Phase asymmetry, phase failure as well as undervoltage and overvoltage are always monitored. The correct phase sequence is monitored when connecting the network for 5s.

If a wrong phase sequence is connected, the phase monitor will switch off. A switch-off is also carried in case of phase asymmetry or phase failure as well as for undervoltage or overvoltage.

If a limit for the corresponding triggering delay time falls short or is exceeded continually, the phase monitor will switch off.

The additional temperature monitoring is done according to the static evaluation process; switch-off will ensue immediately if the temperature limit is reached.

If no temperature sensor is used, a jumper must be connected to the input (delivery state).

After repair of the error and a subsequent reset delay, the system is connected again. A restart following a lock-out is only possible after a reset.

The INT69 UY Diagnose monitors the applied module supply voltage and creates a warning regarding the diagnosis interface as soon as it drops below a fixed specified limit value.

The built-in LED signals the current status of the motor protector (see flash code).

! The mounting, maintenance and operation are to be carried out by an electrician. The valid European and national standards for connecting electrical equipment have to be observed.

Connected sensors and connection lines that extend from the switching cabinet have to feature at least a basic insulation.

See back side for further specifications

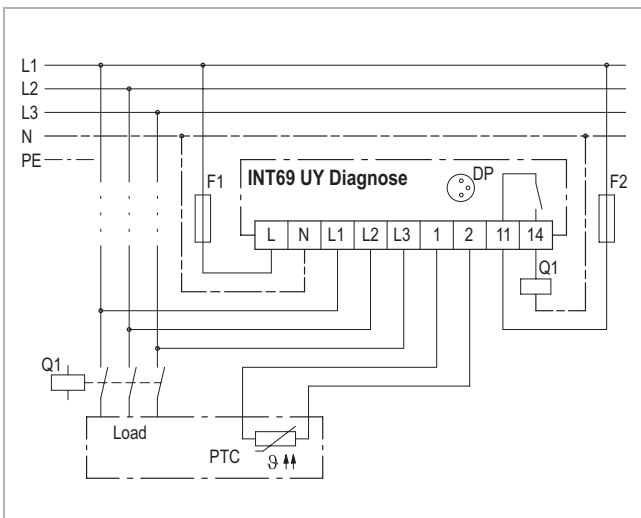

Wiring diagram

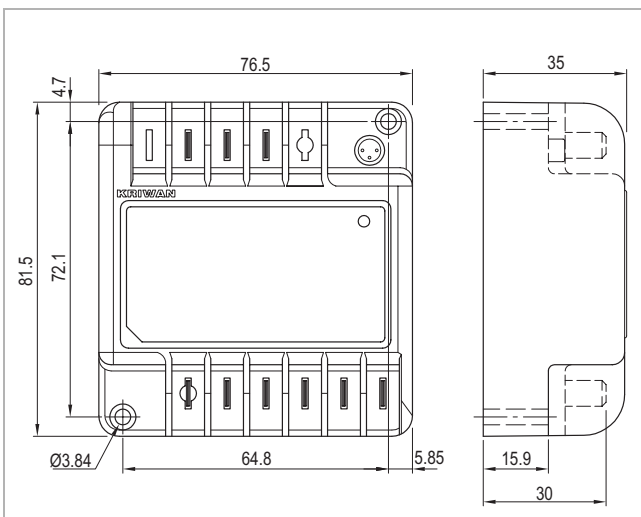

Dimensions in mm

Technical changes reserved

INT69 UY® Diagnose

INT69 UY® Diagnose

Flash code

The KRIWAN flash code allows for a quick and easy status display and troubleshooting.

The flash code consists of a cyclical red and orange flash sequence. The current status can be determined from the number of pulsing flashes.

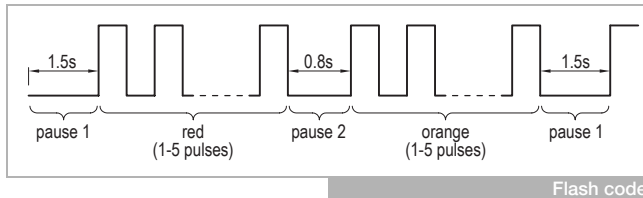

Overview flash code

Green lit	Network available
Red/Orange flashing	Error, system is switched off, see below for description

1st flashing sequence (LED red)	2nd flashing sequence (LED orange)	Description
1	1	Temperature monitoring: Static switch-off, permissible temperature exceeded
	4	Temperature monitoring: Sensor input detected open circuit
2	1	Phase monitoring: Incorrect phase sequence
	2	Phase monitoring: Phase failure/asymmetry
	3	Phase monitoring: Under-/overvoltage
	4	Phase monitoring: Reset delay after "Phase monitoring" error
3	1	General: Supply voltage too low
	5	General: Reset delay after "General" error

Order data

INT69 UY Diagnose (AC 115-240V)	22 A 635 S023
INT69 UY Diagnose (AC 24V)	31 A 635 S023
Accessories and application information	see www.kriwan.com

Technical specifications

Supply voltage	
- 22 A 635 S023	AC 50/60Hz 115-240V ±10% 3VA
- 31 A 635 S023	AC 50/60Hz 24V ±10% 3VA
Permissible ambient temperature T_A	-30...+70°C
Temperature measuring circuits	
- Type	1-2 AMS sensors in series alternative 1-9 PTC sensors acc. to DIN 44081, DIN 44082 in series <1.8kΩ
- $R_{25, total}$	4.5kΩ ±20%
- $R_{trip, static}$	2.75kΩ ±20%
- R_{reset}	10m
- Max. length connection line	
Mains voltage monitoring	
- Monitoring range	AC 50/60Hz, 440-480V
- Accuracy	±12% of the measuring range
- Undervoltage limit 1	330V
- Undervoltage limit 2	308V
- Overvoltage limit 1	552V
- Overvoltage limit 2	576V
- Triggering delay time 1	Approx. 60s
- Triggering delay time 2	Approx. 1s
Phase monitoring	
- Phase sequence	Active for 5s approx. 1s after connection of the network
- Phase asymmetry	Active in approx. 1s after connection of the network
- Limit value switch-off asymmetry	8% ±3%
- Triggering delay time	Approx. 8s
- Limit value switch-off failure	25% ±3%
- Triggering delay time	Approx. 1s
- Reset limit	6% ±3%
Reset delay	
- Undervoltage	5min ±1min
- Overvoltage	5min ±1min
- Phase asymmetry	5min ±1min
- Phase failure	5min ±1min
- Phase sequence	Locked
- Temperature measuring circuits	Undelayed
Resetting the lock or the reset delay	Main reset >5s only possible if there is no error current
Relay	
- Contact	AC 240V 2.5A C300 at least AC/DC 24V 20mA
- Mechanical service life	Approx. 1 million switching cycles
Interface	Diagnose port (DP)
Protection class acc. to EN 60529	IP00
Connection type	6.3mm flat plugs
Housing material	PA glass-fibre-reinforced
Mounting	Screw mounted
Dimensions	Refer to dimensions in mm
Weight	Approx. 200g
Check base	EN 61000-6-2, EN 61000-6-3 EN 61010-1 Overvoltage category II Pollution level 2
Approval	UL File No. E75899 cURus

Technical changes reserved